



## Operation, Maintenance and Care Guide

---

Aluminum Systems

# Windows, Doors, Facades

# Contents

<b>1.0</b>	<b>Safety information</b>	<b>6</b>
<b>1.1</b>	<b>Transport</b>	<b>8</b>
<b>2.0</b>	<b>Operation of windows and window doors</b>	<b>9</b>
2.1	Side-hung unit	9
2.2	Turn/tilt unit	9
2.3	Tilt-before-turn unit	9
2.4	Schüco TipTronic	10
2.5	Crank-operated turn/tilt unit	11
2.6	Double-vent unit	12
a.)	Access and secondary vents with turn function	12
b.)	Access vent with turn/tilt function and secondary vent with turn function	12
2.7	Horizontal pivot window	13
2.8	Vertical pivot window	13
2.9	Adjusting the pivot housing	14
2.10	Limiting stay for horizontal and vertical pivot windows (optional)	14
2.11	Disengaging the limiting stay (cleaning position)	14
2.12	Bottom-hung toplight with concealed fittings or toplight fitting	15
2.13	Disengaging the concealed toplight fitting (cleaning position)	16
2.14	Disengaging the toplight fitting (cleaning position)	16
2.15	Bottom-hung toplight with catch	17
2.16	Bottom-hung toplight with window handle	17
2.17	Disengaging the rebate stay (cleaning position)	18
2.18	Disengaging the safety restrictor and cleaning stay (cleaning position)	18
2.19	Securing stay 200 kg	19
2.20	Limiting stay	19
2.21	Folding sliding unit	20
a.)	Folding sliding unit without side-hung door	20
b.)	Folding sliding unit with side-hung door	21
2.22	Sliding units	22
a.)	Operation with door pull	22
b.)	Operation of the retaining catch without reset	22
c.)	Operation of the retaining catch with reset	22
d.)	Operation with window handle	23
e.)	Operation with push-button window handle	23
f.)	Operation with lockable window handle	23
g.)	Operation with handle	24
h.)	Operation with handle set and profile cylinder	24
i.)	Additional locking point in interlock section	24
2.23	Lift-and-slide units	25
a.)	Operation with handle	25
b.)	Operation with lockable handle	25
c.)	Additional locking point in interlock section	25
2.24	Tilt/slide unit	26
a.)	Fitting with engagement mechanism (mainly doors)	26
b.)	Fitting without engagement mechanism (mainly windows)	26
2.25	Side-hung unit, outward-opening	27
2.26	Top-hung unit, outward-opening	27
2.27	Projected top-hung window, outward-opening	28
a.)	Schüco AWS 102	28
b.)	Schüco AWS 114	29
2.28	Parallel-opening window, outward-opening	30

2.29	Roof window, outward-opening	31
2.30	Lockable handles and burglar-resistant window and balcony door units	32
2.31	Night ventilator	32
a.)	Surface-mounted night ventilator	32
b.)	Concealed night ventilator	33
c.)	Multi-position ventilator	33
2.32	Anti-turn lock	34
2.33	Vent fastener	34
2.34	Roller catch (e.g. for balcony doors)	34
2.35	Limiting stay	35
2.36	Anti-slam fitting	35
<b>3.0</b>	<b>Operation: doors</b>	<b>36</b>
3.1	Door locks, external door with door pull	36
3.2	Door locks, external door with door handle	36
3.3	Door locks, door with intruder catch	37
3.4	Door locks, door with automatic locking	38
3.5	Door locks, door with electric opener	38
3.6	Door locks, door with electric locking	39
3.7	Door lock, door with lock with electric coupling	39
3.8	Door locks, door with locking cylinder with locking thumb turn	39
3.9	Door locks, double-leaf doors	40
3.10	Door locks, double-leaf door with emergency lever bolt (panic function)	41
a.)	Secondary leaf locking via turn handle	41
b.)	Secondary leaf locking via emergency push bar	42
3.11	Magnetic door stop	43
3.12	Door stop	43
3.13	Door closer	43

<b>4.0</b>	<b>Misuse</b>	<b>44</b>
<b>5.0</b>	<b>Cleaning and care</b>	<b>45</b>
5.1	General information	45
5.2	Cleaning and care materials	45
5.3	General cleaning advice	46
<b>6.0</b>	<b>Maintenance</b>	<b>47</b>
6.1	Cleaning the drainage slot	48
6.2	Cleaning the roller guides of sliding and folding units	48
6.3	Checking and lubricating the gaskets	48
6.4	Maintenance of fittings components	49
6.5	Doors	50
6.6	Maintaining the locking cylinder	50
6.7	Door hinges	51
<b>7.0</b>	<b>Correct ventilation</b>	<b>52</b>
7.1	Ventilating in summer/winter	52
7.2	Blast ventilation	53
<b>8.0</b>	<b>Advice and repairs</b>	<b>54</b>
8.1	Maintenance agreement	54

## 1.0 Safety information

When using aluminium units, take note of the hazards listed below.



### **Danger of falling**

There is a risk of falling out of open units.  
Do not leave open units unsupervised.

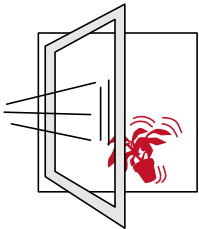

### **Danger of objects falling out when units slam shut**

Open units may slam in a draught which may knock over adjacent objects.  
If there is wind or a draught, please shut windows and window vents. There is wind or a draught if an open window or window vent opens or closes uncontrollably due to a positive or negative wind load.

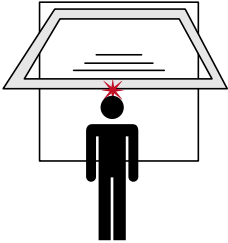

#### **Danger of injury from vents swinging open**

Bottom-hung units can unintentionally swing open when the stays are disengaged. There is a risk of injury from horizontal and vertical pivot windows swinging wide open during opening and closing.

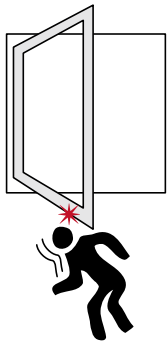

#### **Danger of injury from open units**

There is a high risk of injury when working underneath open windows. Shut open windows before working underneath them and before children enter the room.

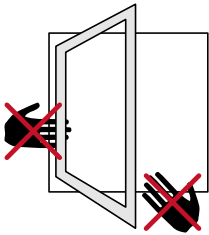

#### **Danger of crushing**

Be careful not to trap fingers between the window vent or door leaf and the outer frame when operating windows, patio doors or entrance doors, as well as power-operated windows.



#### **INFORMATION**

You can find additional safety recommendations in the following instructions. When operating windows and doors that are insert units in facade constructions, the following descriptions apply accordingly.



#### **WARNING**

Only allow trained personnel from specialist companies to carry out any work involving transport, installation, dismantling, maintenance and repair.

## 1.1 Transport



### WARNING

#### **Risk of death from improper handling and transport.**

Incorrect handling and improper transport of the units could lead to dangerous situations and cause serious accidents and even death. Therefore, only allow specialist companies to carry out handling and transport tasks including assembly and installation.



### INFORMATION

In addition, observation of the following guidelines is recommended: TLE.01 of the German Association of Window and Façade Manufacturers (VFF)

Proper handling of ready-to-install windows and external doors during transport, storage and installation

Reaction forces may result in damage to or improper loads acting on the installed fittings during transport and loading and unloading processes, in particular when using aids such as suction cups, transport nets, forklift trucks or cranes. Therefore, observe the following for all transport, loading and unloading processes:

- ▶ Always select the points of application of force so that the resulting reaction forces are dispersed according to the constructive design of the fittings components for the planned installation position. This applies in particular to the storage areas.
- ▶ Always use the transport pin tailored to the respective rebate space (e.g. spacer pads) to hold the vent in its intended position in the outer frame during transport and thus transfer the reaction forces directly from the vent through the outer frame.
- ▶ Transport the units in their intended installation position if possible so that the resulting reaction forces are dispersed according to the constructive design of the fittings components for the planned installation position. This applies in particular to the storage areas. If transport in the intended installation position is not possible, take the vent out and transport it separately from the accompanying outer frame.

## 2.0 Operation of windows and window doors

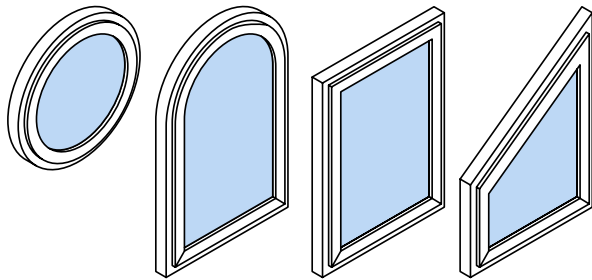

The following operating instructions apply to all types of unit and all opening types.

### 2.1 Side-hung unit

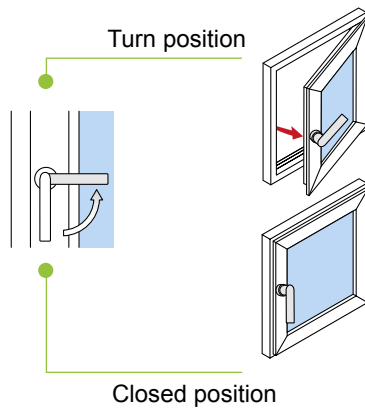

### 2.2 Turn/tilt unit

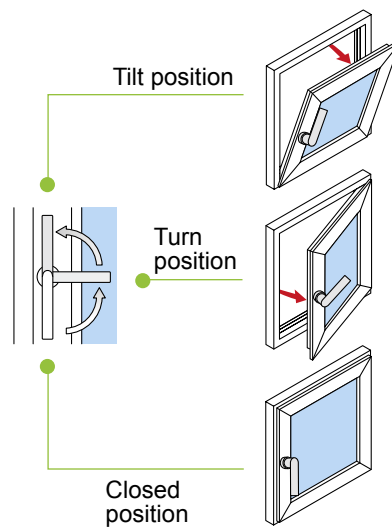

### 2.3 Tilt-before-turn unit

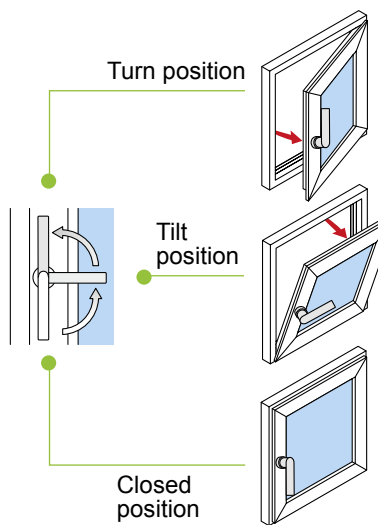

## 2.4 Schüco TipTronic unit



### WARNING

When operating the window, be careful not to trap fingers between the window vent and frame.



### INFORMATION

Can only be operated when the "power supply" is switched on.

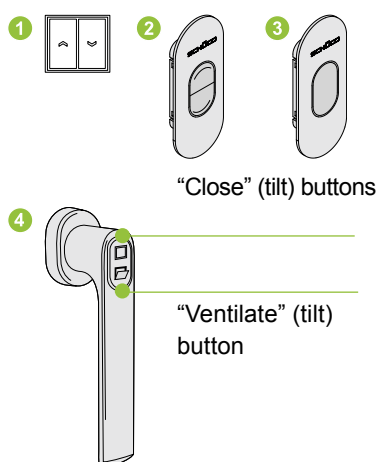

### Methods of operation:

- 1 Momentary contact switch
- 2 Rocker switch
- 3 Operating switch
- 4 e-handle

### Blue LED

1. Lights up during normal operation
2. Flashes during events. You can find the meaning in the Schüco TipTronic operating instructions/commissioning instructions.

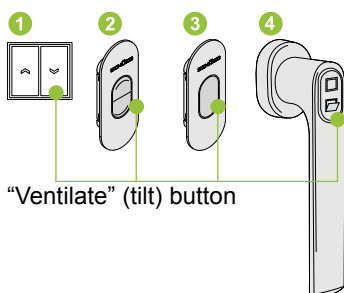

### Open the vent

- ▶ Briefly press the "Ventilate" button: vent opens (Movement can be stopped by pressing another button).

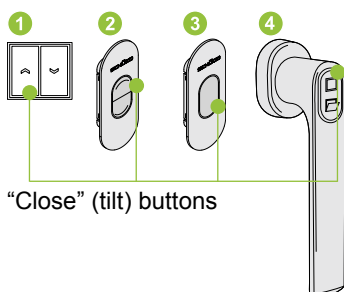

### Close the vent

- ▶ Press the "Close" button: vent moves to the closed position.

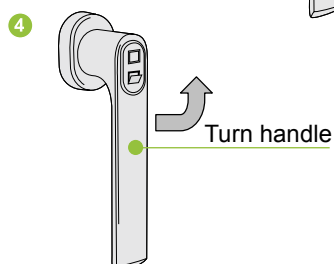

### Opening in the turn position (only for turn/tilt units)

- ▶ Turn handle through 90° into the turn position: the vent is unlocked and can be opened manually.

### Close from the turn position

- ▶ Close vent manually and turn handle through 90° into the closed position: vent is locked automatically.

## 2.5 Crank-operated turn/tilt unit

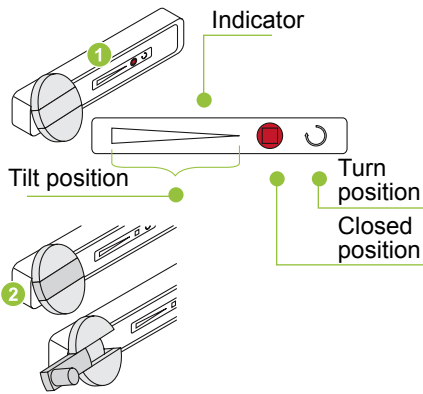

The crank housing has a position indicator. The red indicator shows the position of the fittings. **1**



### NOTE

Stop turning before the red indicator moves beyond the end position, otherwise the fitting will be destroyed.

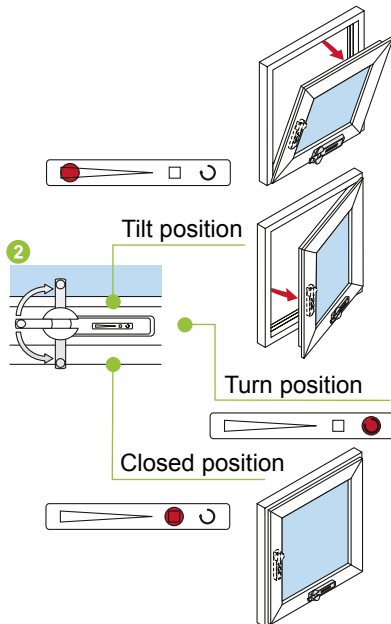

### Open window in the tilt position

1. Pull out the crank handle from its base. **2**
2. Turn the crank handle to the left until the desired opening angle is reached. The opening angle is infinitely adjustable. The red indicator shows the tilt position.



### Close from the tilt position

- Turn the crank handle to the right until the red indicator shows the closed position.



### Open in the turn position

1. Pull out the crank handle from its base. **2**
2. Turn the crank handle to the right until the red indicator shows the turn position.
3. Open the vent.



### Close from the turn position

1. Close the vent.
2. Turn the crank handle to the left until the red indicator shows the closed position.



## 2.6 Double-vent unit

### a.) Access and secondary vents with turn function

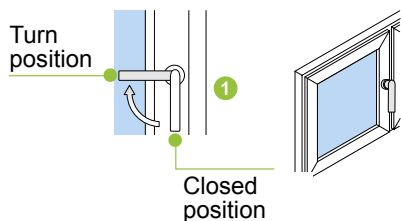

**Open the access vent**

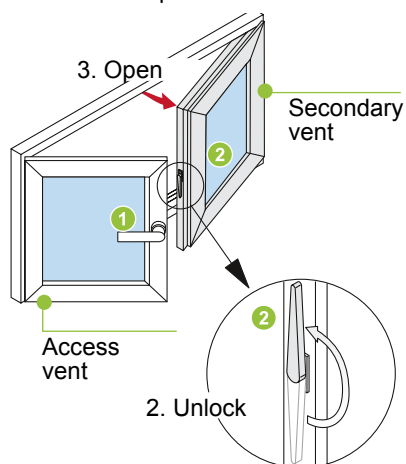

**Open the secondary vent**

1. Open the access vent in the turn position. ①
2. Unlock rebate lever. ②
3. Open secondary vent.

**Close in the reverse order.**

### b.) Access vent with turn/tilt function and secondary vent with turn function

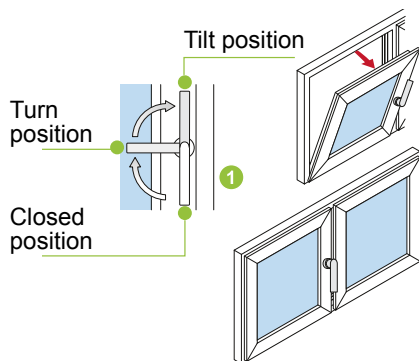

**Open the access vent**

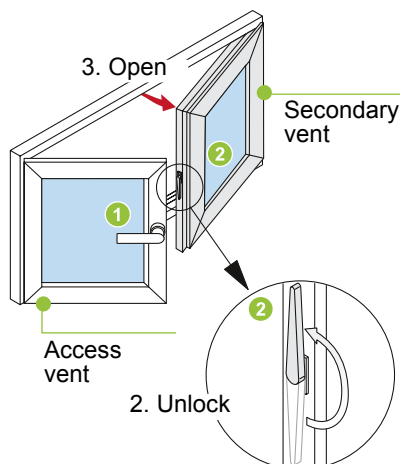

**Open the secondary vent**

1. Open the access vent in the turn position. ①
2. Unlock rebate lever. ②
3. Open secondary vent.

**Close in the reverse order.**

## 2.7 Horizontal pivot window

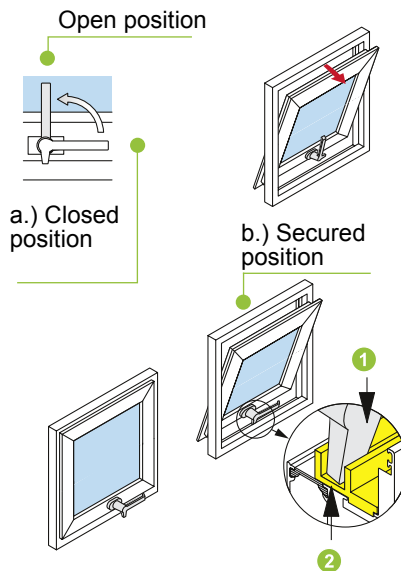

The pivots for the horizontal pivot windows are fitted with brakes to hold the unit open. The horizontal position of the turn handle has two functions.

- a.) Closing the horizontal pivot window.
- b.) Secure the horizontal pivot window in the night ventilation position.

### Secure the horizontal pivot window

1. Open horizontal pivot window.
2. Turn the handle to the horizontal position until the spur on the handle fits into the groove in the window frame.



### WARNING

If the vent moves too easily, the brake in the window fittings must be adjusted by a qualified technician, so that it cannot fall shut in an uncontrolled way.

The pivots must not be oiled or lubricated, otherwise the vent could swing open and shut in an uncontrolled way.

## 2.8 Vertical pivot window

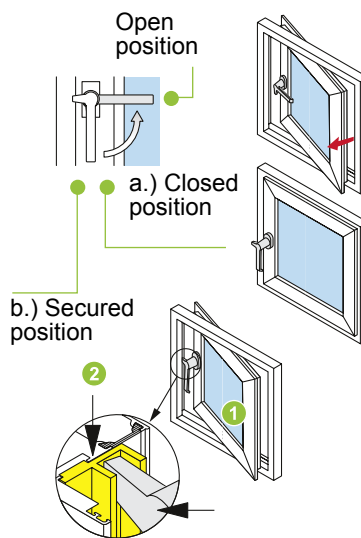

The vertical position of the turn handle has two functions.

- a.) Closing the vertical pivot window.
- b.) Secure the vertical pivot window in the night ventilation position.

### Secure the vertical pivot window

1. Open the vertical pivot vent.
2. Turn the handle to the horizontal position until the spur on the handle fits into the groove in the window outer frame.



### WARNING

The pivots must not be oiled or lubricated, otherwise the vent could swing open and shut in an uncontrolled way.

## 2.9 Adjusting the pivot housing



Pivot housing, external view

Prior to glazing, the pivot housing should be adjusted in the following sequence:

1. Turn the horizontal/vertical pivot window to the 180° open position
2. Tighten adjustment screws 1 and 2 (see illustration) as much as possible in the right-hand and left-hand pivot housing
3. Close and open the horizontal/vertical pivot window 5 times through 180°
4. Glaze the window
5. Unscrew adjustment screws 1 and 2 (for Schüco TipTronic unscrew until the window stops in any opening position but is still comfortable and easy to use).

As this is a mechanical brake, we recommend carrying out annual maintenance work to check for wear and tear.

For large pane weights and wide, low, horizontal pivot windows, we recommend using an additional limiting stay

## 2.10 Limiting stay for horizontal and vertical pivot windows (optional)

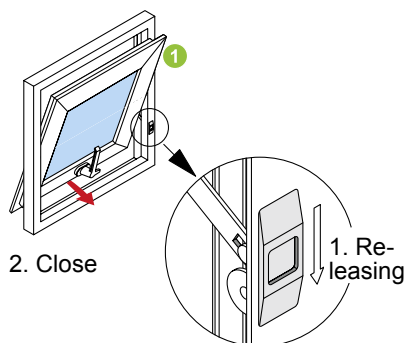

2. Close

The limiting stay limits the opening angle of the window vent and locks it in the open position.

### Open the window

- ▶ Open the window until the limiting stay engages.  
See chapters 2.7 and 2.8 for opening function.

### Close the window.

1. Release the limiting stay by sliding the securing catch.
2. Close the horizontal pivot window.

## 2.11 Disengaging the limiting stay (cleaning position)

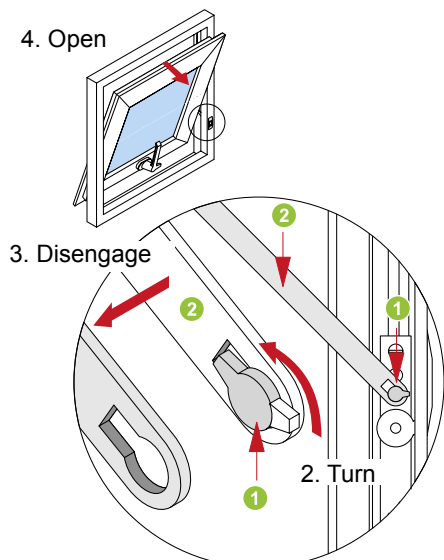

4. Open

3. Disengage

2. Turn



### WARNING

Support the window vent before disengaging the fitting. Ensure that the entire weight of the vent is supported. Supporting the vent will prevent it swinging open freely. Ensure that there are no people or objects within the opening arc of the window.

In order to open the window wide for cleaning, the limiting stay must be disengaged.

1. Open the vent. See chapters 2.7 and 2.8 for opening function.
2. Turn safety catch until it is flush with the recess.
3. Disengage main arm. ②
4. Open the vent wider.

**To re-engage, follow the same procedure in reverse order.**

## 2.12 Bottom-hung toplight with concealed fittings or toplight fitting

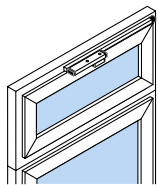

Closed position

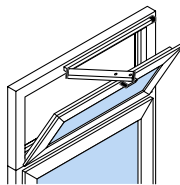

Open position

### Methods of operation:

- 1 Lever handle
- 2 Crank handle
- 3 Electric opener

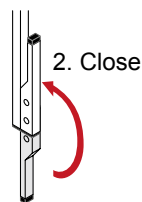
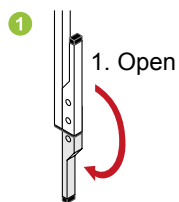

### Open and close

#### 1 Using a handle

- 1. Open the toplight by pulling down the handle.
- 2. Close the toplight by pulling up the handle.

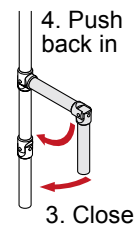
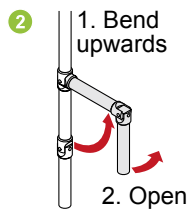

#### 2 Using a crank handle

- 1. Remove the crank handle from the holder and move into the turn position.
- 2. Open toplight by turning the crank handle to the left.
- 3. Close the toplight by turning the crank handle to the right.
- 4. Fix the crank handle to the holder.

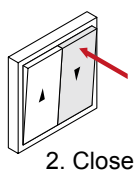
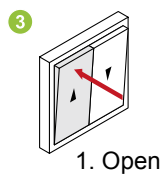

#### 3 Using electric opener

- 1. Press the button until the toplight is opened to the desired width.
- 2. Press the button until the toplight is fully closed.



### INFORMATION

The toplight is prevented from opening onto the unit below by a rebate or security stay.

## 2.13 Disengaging the concealed toplight fitting (cleaning position)



### WARNING

Support the bottom-hung vent before disengaging the fitting. Ensure that the entire weight of the vent is supported. Supporting the bottom-hung vent will prevent it swinging open freely. Ensure that there are no people or objects within the opening arc of the window. For Schüco AvanTec tilt pivots, the vent can be opened to a maximum position of 90°. Also give the vent additional support as otherwise irreparable damage will be caused.

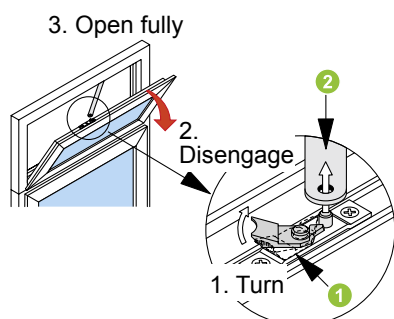

In order to open the bottom-hung vent wide enough for cleaning, the toplight fitting must be disengaged.

### Open the bottom-hung vent.

1. Support the open vent and turn the safety catch. ①
2. Disengage main arm. ②
3. Slowly open the vent wide.

To re-engage, follow the same procedure in reverse order.

## 2.14 Disengaging the toplight fitting (cleaning position)

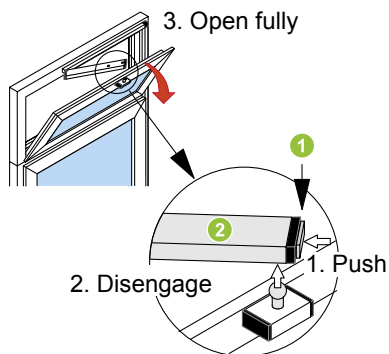

In order to open the bottom-hung vent wide enough for cleaning, the toplight fitting must be disengaged.

### Open the bottom-hung vent.

1. Support the open vent and press the locking button. ①
2. Disengage main arm. ②
3. Slowly open the vent wide.

To re-engage, follow the same procedure in reverse order.

## 2.15 Bottom-hung toplight with catch

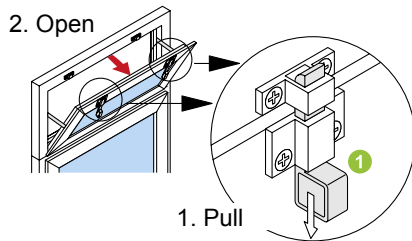

### Open

1. Release both catches by pulling the loops. ①
2. Open the bottom-hung vent.

To close, push toplight until the catches engage.

## 2.16 Bottom-hung toplight with window handle

### Window handle at top

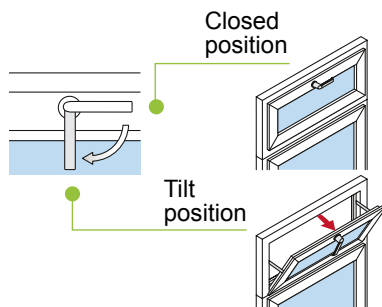

### INFORMATION

The toplight is prevented from opening onto the unit below by a rebate or security stay.



### WARNING

For Schüco AvanTec tilt pivots, the vent can be opened to a maximum position of 90°. Also give the vent additional support as otherwise irreparable damage will be caused.

### Window handle at side

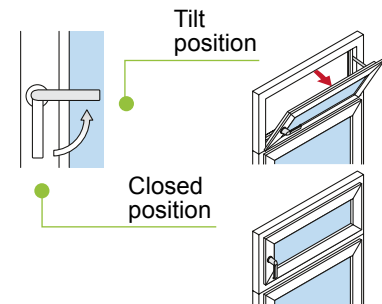

## 2.17 Disengaging the rebate stay (cleaning position)



### WARNING

Support the bottom-hung vent before disengaging the rebate stay. Ensure that the entire weight of the vent is supported. Supporting the bottom-hung vent will prevent it swinging open freely. Ensure that there are no people or objects within the opening arc of the window.

For Schüco AvanTec tilt pivots, the vent can be opened to a maximum position of 90°. Also give the vent additional support as otherwise irreparable damage will be caused.



### NOTE

When opening the bottom-hung unit, ensure that the surface-mounted fittings (window handles) are not able to damage the unit below.

In order to open the bottom-hung vent fully for cleaning, disengage the rebate stays at the sides.

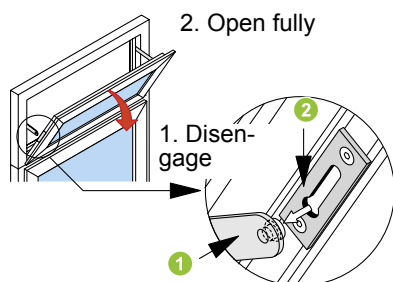

### Open the bottom-hung vent.

1. Push the open vent so far out that the stay arm can be removed from its guide. **1**
2. Disengage main arm. **2**
3. Slowly open the vent wide.

**To re-engage, follow the same procedure in reverse order.**

## 2.18 Disengaging the safety restrictor and cleaning stay (cleaning position)



### WARNING

Support the bottom-hung vent before disengaging the rebate stay. Ensure that the entire weight of the vent is supported. Supporting the bottom-hung vent will prevent it swinging open freely. Ensure that there are no people or objects within the opening arc of the window.

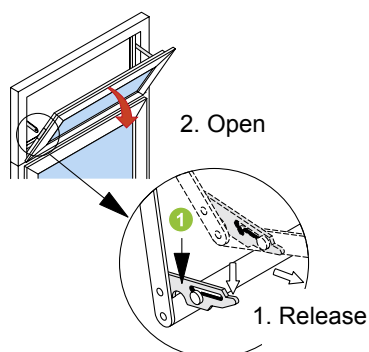

In order to open the bottom-hung vent fully for cleaning, disengage the rebate stays at the sides.

### Open the window vent.

1. Support the open vent and release from the ratchet. **1**
2. Slowly open the vent.

**Re-engage: after closing the bottom-hung vent, the security stay re-engages automatically.**

## 2.19 Securing stay 200 kg



### WARNING

Do not unscrew the fixing screws of the stay arm for cleaning. The fixing screws are only permitted to be unscrewed by qualified personnel for installation and dismantling.

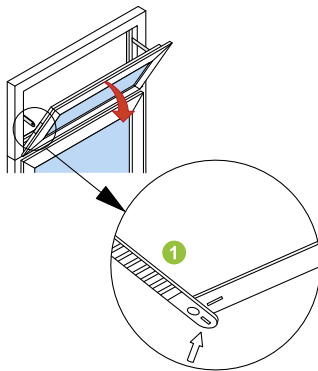

### Secure the bottom-hung vent

1. Support the open vent and push onto the stay arm. ①
2. The vent is now in the secured position.

## 2.20 Limiting stay



### WARNING

Do not unscrew the fixing screws of the stay arm for cleaning. The fixing screws are only permitted to be unscrewed by qualified personnel for installation and dismantling.

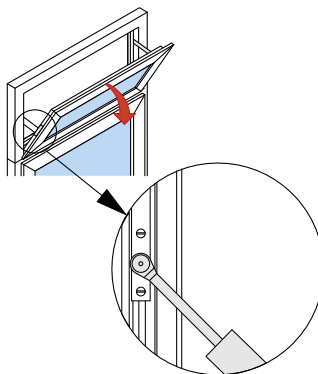

## 2.21 Folding sliding unit

### a.) Folding sliding unit without side-hung door



#### WARNING

During opening and closing, do not place hands in the area where the units fold, as there is a danger that fingers may become trapped.



#### INFORMATION

The operation described only applies to the unit type shown.

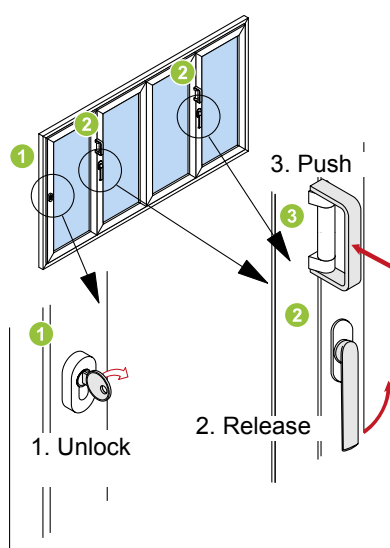

#### Open

1. Unlock by turning the key. ①
2. Release the locking point on the folding units by turning the lever handle upwards. ②
3. Open leaf by pushing the handles. ③
4. Open leaf.

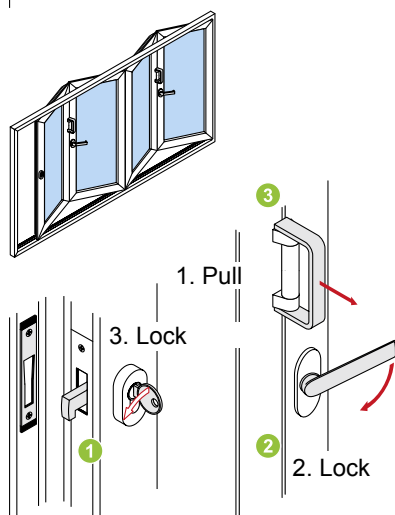

#### Close

1. Pull the leaf into the frame using the door pulls. ③
2. Secure the locking point on the folding units by turning the lever handle downwards. ②
3. Lock by turning the key. ①

## b.) Folding sliding unit with side-hung door



### WARNING

During opening and closing, do not place hands in the area where the units fold, as there is a danger that fingers may become trapped.



### INFORMATION

The operation described only applies to the unit type shown.

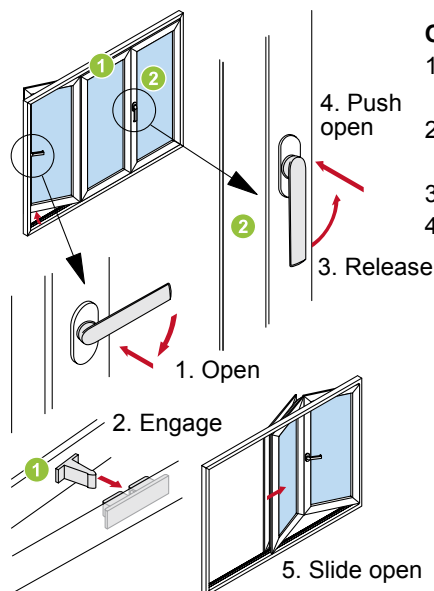

### Open

1. Open side-hung door through 180°. Engage in the catch of the adjacent leaf. ①
2. Release the locking point on the folding units by turning the lever handle upwards. ②
3. Push the handle up
4. Slide the folding units open

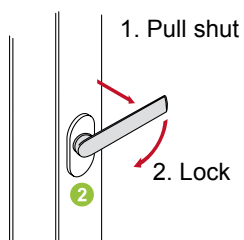

### Close

1. Pull the sliding units shut using the door pulls. ②
2. Lock the folding units
3. Close the side-hung door.

## 2.22 Sliding units

### a.) Operation with door pull

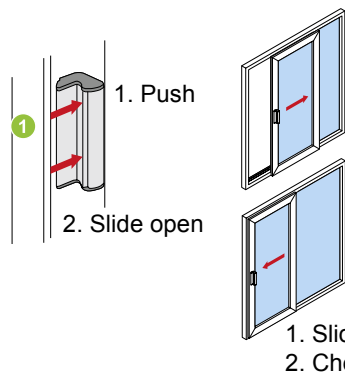

#### Open

1. Unlock the sliding vent by pressing down on the inside of the handle. ①
2. Push the sliding vent open.

#### Close

1. Push the sliding vent shut.
2. Ensure that the locking point of the handle engages.

1. Slide shut
2. Check the door pull has engaged

### b.) Operation of the retaining catch without reset

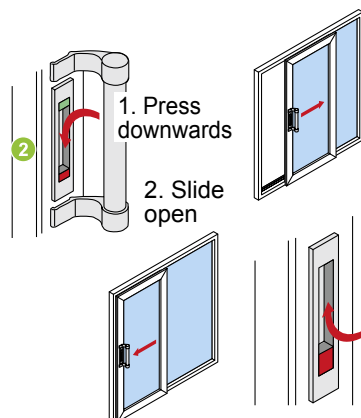

1. Slide shut
2. Push upwards

#### Open

1. Unlock the sliding vent by pushing the retaining catch downwards. Signal colour = green. ②
2. Push the sliding vent open using the flush handle/door pull.

#### Close

1. Push the sliding vent shut using the flush handle/door pull.
2. Lock the sliding vent by pushing the retaining catch upwards. Signal colour = red. ②

### c.) Operation of the retaining catch with reset

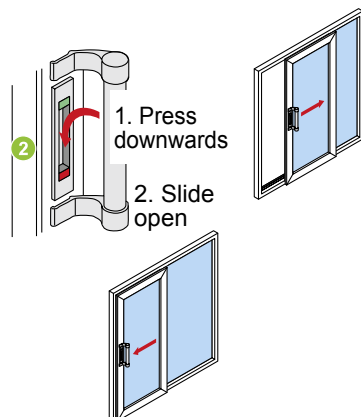

1. Slide shut

#### Open

1. Unlock the sliding vent by pushing the retaining catch downwards and press and hold the retaining catch – Signal colour on the locking unit = Green. ②
2. Push the sliding vent open using the flush handle/door pull. As soon as the locking area has been cleared, pressure on the retaining catch can be released – Signal colour on the locking unit = Red.

#### Close

1. Push the sliding vent shut using the flush handle/door pull. The lock automatically re-engages and the vent is locked. Caution: There is a danger of locking oneself out.

To conserve the locking mechanism, we recommend manually supporting the locking process (by pushing the retaining catch downwards).

**d.) Operation with window handle**

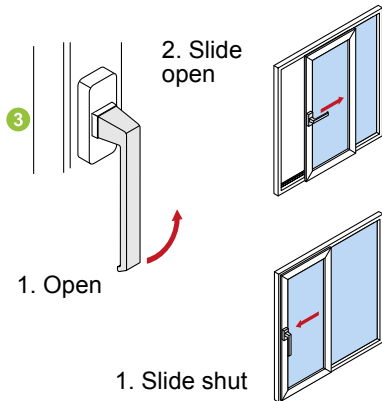

**Open**

1. Turn handle 90° anti-clockwise. 3
2. Push the sliding vent open.

**Close**

1. Push the sliding vent shut.
2. Turn handle 90° clockwise. 3

**e.) Operation with push-button window handle**

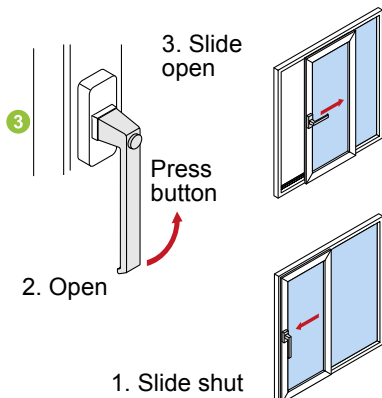

**Open**

1. Press the push-button on the handle.
2. Turn handle 90° anti-clockwise and release the push-button. 3
3. Push the sliding vent open.

**Close**

1. Push the sliding vent shut.
2. Turn handle 90° clockwise. 3

**f.) Operation with lockable handle**

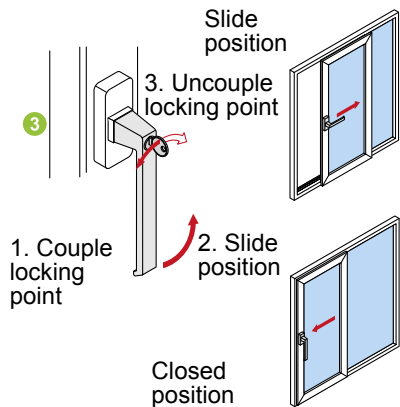

**Open**

1. Turn the key on the handle to the right (unlock).
2. Turn handle 90° anti-clockwise. 3
3. Push the sliding vent open.

**Close**

1. Push the sliding vent shut.
2. Turn handle 90° clockwise. 3
3. Turn the key on the handle to the left (lock).

### g.) Operation with handle

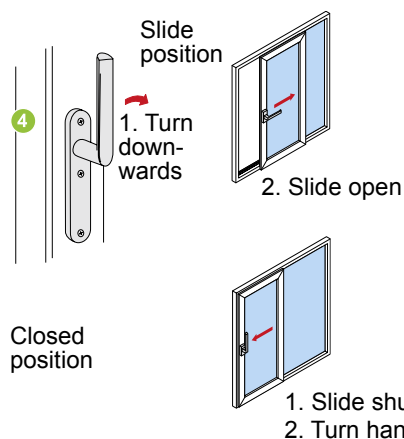

#### Open

1. Turn handle 90° clockwise. 4
2. Push the sliding vent open.

#### Close

1. Push the sliding vent shut.
2. Turn handle 90° anti-clockwise. 4

### h.) Operation with handle and profile cylinder

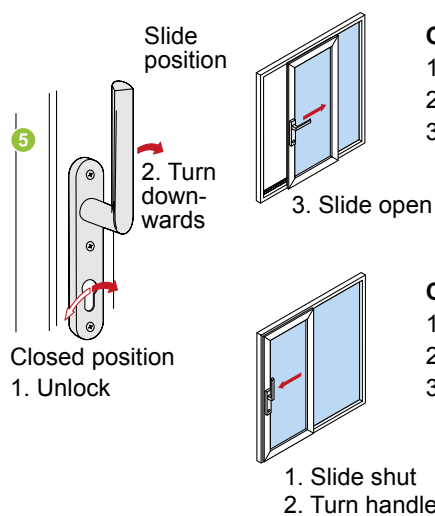

#### Open

1. Unlock the sliding vent using the profile cylinder key.
2. Turn handle 90° clockwise. 5
3. Push the sliding vent open.

#### Close

1. Push the sliding vent shut.
2. Turn handle 90° anti-clockwise. 5
3. Lock vent with key.

### i.) Additional locking point in interlock section

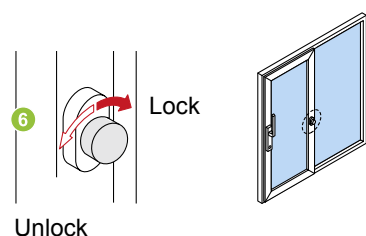

#### Open

1. Press in and turn (unlock) turning knob of centre locking point to the left. 6
2. Operate unit as described.

#### Close

1. Close the unit.
2. Press in turning knob of centre locking point until it engages and turn to the right (lock). 6

## 2.23 Lift-and-slide units



### WARNING

When closing, do not put hands in the striker area of the vent, as fingers could become trapped.

#### a.) Operation with handle

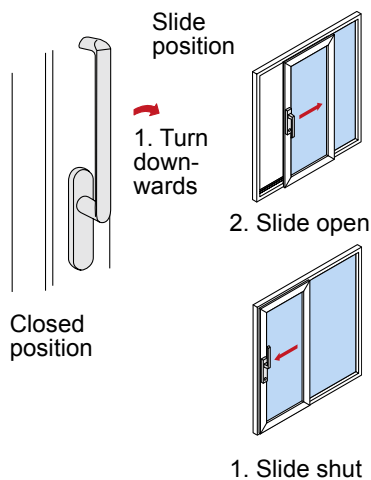

#### Open

1. Turn handle downwards through 180°. ①
2. Push vent open.

#### Close

1. Push vent shut.
2. Turn handle upwards through 180°. ①

#### b.) Operation with lockable handle

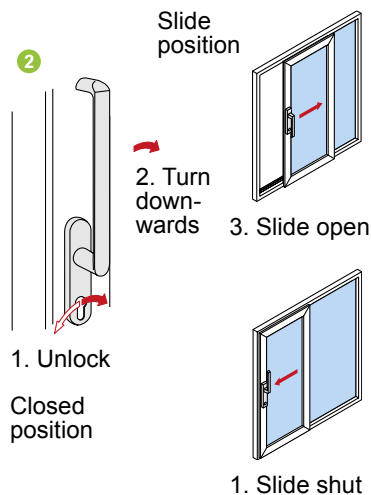

#### Open

1. Unlock vent with the key.
2. Turn handle downwards through 180°. ②
3. Push vent open.

#### Close

1. Push vent shut
2. Turn handle upwards through 180°. ②
3. Lock vent with key.

#### c.) Additional locking point in interlock section

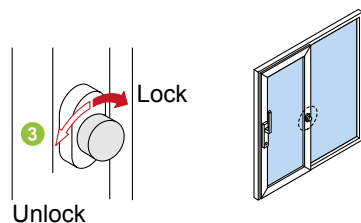

#### Open

1. Press in and turn (unlock) turning knob of centre locking point to the left. ③
2. Operate unit as described.

#### Close

1. Close the unit.
2. Press in turning knob of centre locking point until it engages and turn to the right (lock). ③

## 2.24 Tilt/slide unit

### a.) Fitting with engagement mechanism (mainly doors)

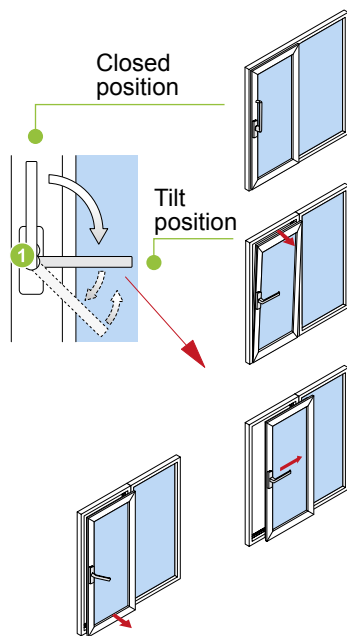

#### Tilt position

- ▶ Bring the sliding vent into the tilt position by turning the handle through 90°. ①

#### Slide position

1. Release sliding vent at the bottom by continuing to press down on the handle.
2. Allow handle to spring back and push the sliding vent open.

#### Close

1. Close sliding units until the vent automatically moves into the bottom locking point (tilt position).
2. Close the sliding units by turning the crank handle upwards. ①

### b.) Fitting without engagement mechanism (mainly windows)

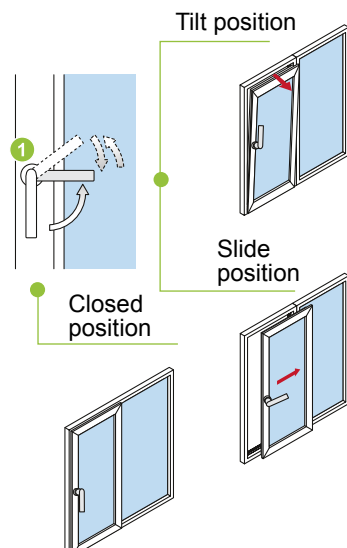

#### Tilt position

- ▶ Bring the sliding vent into the tilt position by turning the handle through 90°. ①

#### Close from the tilt position

- ▶ Close the vent and turn the handle downwards through 90° into the closed position. ①

#### Slide position

1. Place the vent in the tilt position.
2. Slide open the vent at the bottom by continuing to press down on the handle (handle springs back). ①

#### Close from the slide position

- ▶ Slide the vent to and then push the vent into the closed position (if necessary with both hands) and then turn the window handle downwards. ①

## 2.25 Side-hung unit, outward-opening

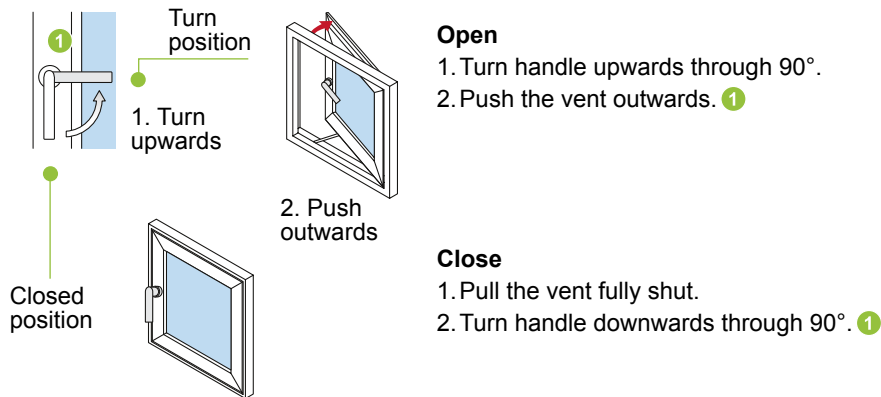

## 2.26 Top-hung unit, outward-opening, with opening stay



With negative wind loads, the rebate stay can be pulled into the end position causing the window to shut. Ensure that there are no objects or body parts in the stay and rebate area (risk of injury).

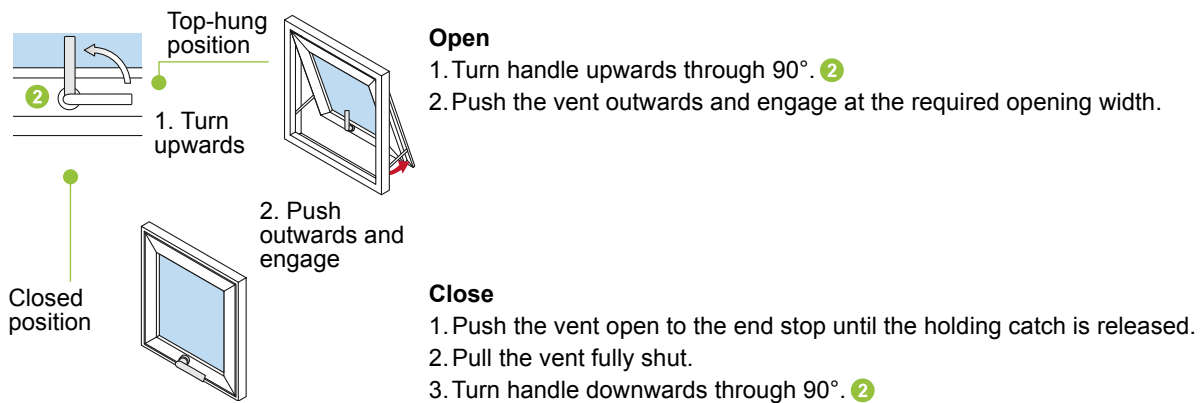

## 2.27 Projected top-hung window, outward-opening



### WARNING

With negative wind loads, the rebate stay can be pulled into the end position causing the window to shut. Ensure that there are no objects or body parts in the stay and rebate area (risk of injury)



### INFORMATION

For outward-opening windows in particular, we recommend the use of a motorised wind and rain sensor.

#### a) Schüco AWS 102

#### Methods of operation

- ① Manually operated  
(façade and window)

The opening angle can be restricted by installing a ratchet stay with several ratchet positions.

(Warning: This is not an anti-slam device)

(façades only)

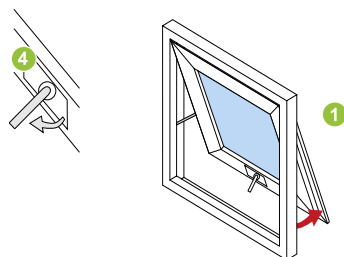

#### Open (façade)

1. Turn handle through 90° to the room side.
2. Push the vent outwards. ④

#### Close (façade)

1. Pull vent fully shut.
2. Turn handle towards the window through 90°. ④

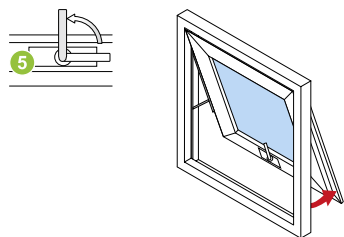

#### Open (windows)

1. Turn handle upwards through 90°.
2. Push the vent outwards. ⑤

#### Close (windows)

1. Pull vent fully shut.
2. Turn handle downwards through 90°.

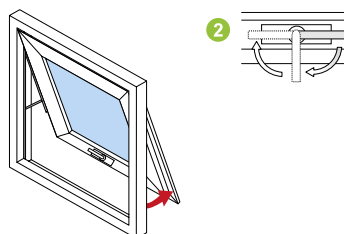

- ② Additional unit ratchet stay (façades only)

The ratchet stay can be used to restrict the vent at any opening width (fixing); operated using a handle

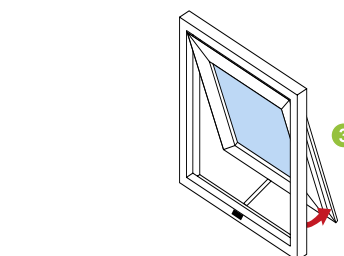

- ③ Motor operated with chain actuator

**b) Schüco AWS 114****Methods of operation****1** Manually operated

The opening angle can be limited by moving the stop position in the C-shaped track.

(Caution, there is no anti-slam fitting)

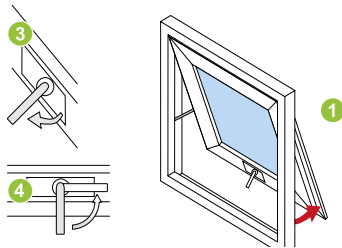
**Open**

1. Turn handle through 90° to the room side. **3**
2. Push the vent outwards.

**Close**

1. Pull vent fully shut.
2. Turn handle parallel to the window. **4**

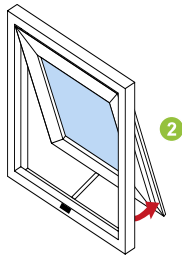
**2** Motorised operation with concealed Schüco TipTronic motors for locking and opening

Note: safety class II can be implemented by means of the anti-finger-trap protection software; safety class IV by means of additional sensor strips.

Operated using

- a) Momentary contact switch
- b) Rocker switch
- c) Operating switch

## 2.28 Parallel-opening window, outward-opening



### WARNING

Ensure that there are no objects or body parts in the stay and rebate area (risk of injury).

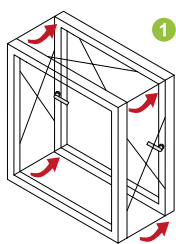

1

### Methods of operation

1 Manually operated using two handles

The opening angle can be limited by moving the stop position in the C-shaped track.

(Caution: there is no anti-slam fitting)

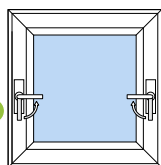

3

### Open

1. Turn handles inwards through 90° towards the side outer frame (right and left). 3

2. Push the vent outwards.

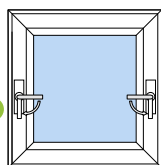

4

### Close

1. Pull vent fully shut.

2. Place handles parallel to the outer frame. 4

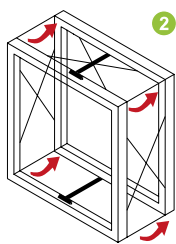

2

2 Motor operated with chain actuator

Operated using

a) Momentary contact switch

b) Rocker switch

c) Operating switch

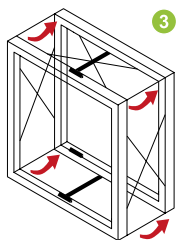

3

3 Motor operated with chain actuator and locking motors

Operated using

a) Momentary contact switch

b) Rocker switch

c) Operating switch

### Motor operation

#### Open

► Open using chain motor and lock using locking motors

## 2.29 Roof window, outward-opening

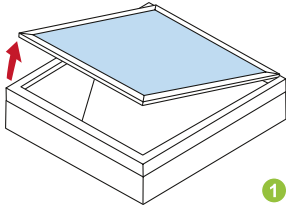

### WARNING

Support the roof vent before pulling the splint from the surface-mounted fixing for the motor. Ensure that the entire vent weight is supported during installation or maintenance. Supporting the vent will prevent it from slamming shut. Ensure that there are no objects or body parts in the rebate area (risk of injury).

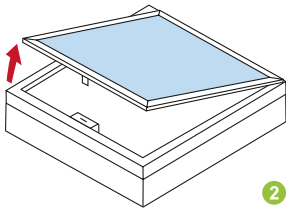

### Methods of operation

- 1 With crank handle
- 2 With chain or linear drive (power-operated)

### Operated using

- a) Individual control (momentary contact switch)
- b) Group control
- c) SHEVS compact control unit



### NOTE

The use of a wind and rain sensor is recommended for the power-operated unit for the loft conversion. A magnetic switch kit can be used as a closing monitor.

## 2.30 Lockable handles and burglar-resistant window and balcony door units

These units are fitted with a lockable handle or with a handle with pushbutton lock.



### INFORMATION

Full burglar resistance is only guaranteed when the unit is locked.

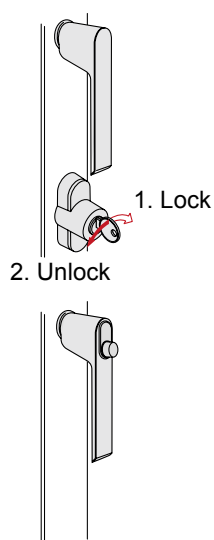

#### To lock (lockable handle):

1. Close the vent.
2. Lock by turning the key to the right.

#### To unlock (lockable handle):

1. Unlock by turning the key to the left.
2. Move handle into the desired position (turn or turn/tilt).

#### To lock (pushbutton lock):

1. Close the vent.
2. In the closed position, the handle locks automatically.

#### To unlock (pushbutton lock):

1. Unlock the handle by pressing the pushbutton and simultaneously turning the handle.
2. Move handle into the desired position.

## 2.31 Night ventilation

### a.) Surface-mounted night ventilator

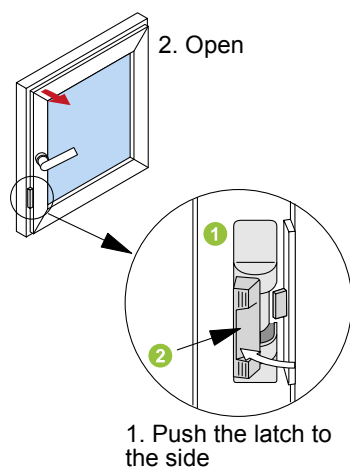

The surface-mounted night ventilator limits the turn and tilt positions of the vent to a small opening width. ①

The night ventilator is always in operation.

After closing the unit, the night ventilator engages automatically.

#### Open the window wide:

1. Push the latch to the side. ②
2. Open unit.

**b.) Concealed night ventilator**

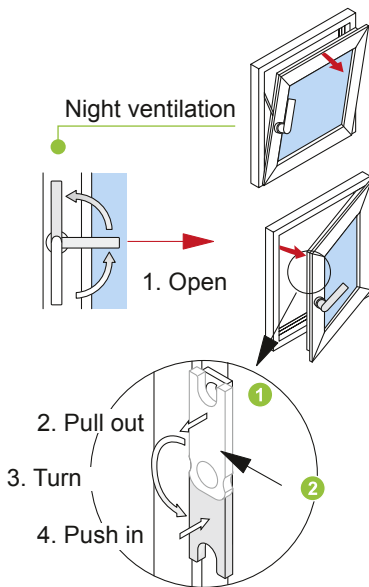

The concealed night ventilator limits the turn and tilt positions of the vent to a small opening.

To open the vent completely in the tilt position, the night ventilator must be disengaged. ①

**To disengage the night ventilator:**

1. Open the unit in the turn position. ②
2. Pull out the latch.
3. Turn it downwards.
4. Push in again.
5. Der Flügel lässt sich in die volle Kippstellung bringen.

The night ventilator must be re-engaged manually.

**To lock the night ventilator:**

1. Open the unit in the turn position.
2. Pull out the latch. ②
3. Turn it upwards.
4. Push in again.
5. The vent is limited to the night ventilation tilt position again.

**c.) Multi-position ventilator**

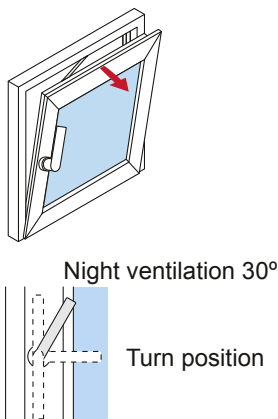

The multi-position night ventilator restricts the tilt position of the vent to 4 different opening widths.

To open the vent completely in the tilt position, the night ventilator must be disengaged.

**To disengage the night ventilator:**

1. Move handle into tilt position and close window.
2. Then move handle into turn position and open window.

**To lock the night ventilator:**

1. Open unit slightly in tilt position
2. Move handle by approx. 30° until it engages in the turn position.

The vent can be restricted to 4 different night ventilation positions.

### 2.32 Anti-turn lock

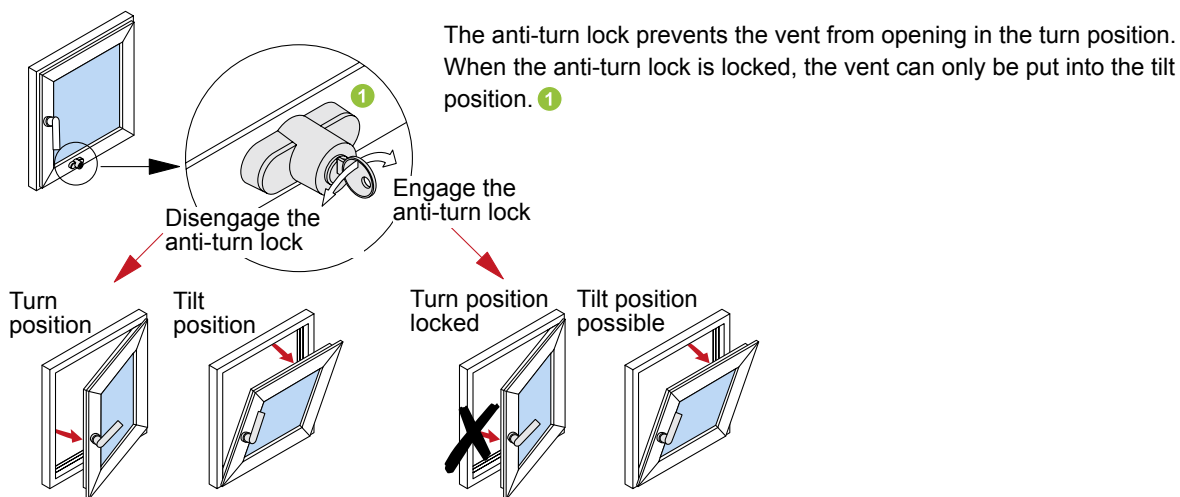

### 2.33 Vent fastener

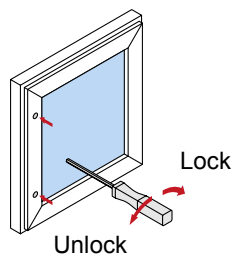

Window locking without handle/locking bar fitting. The windows are locked using a 4 mm Allen key.

### 2.34 Roller catch (e.g. for balcony doors)

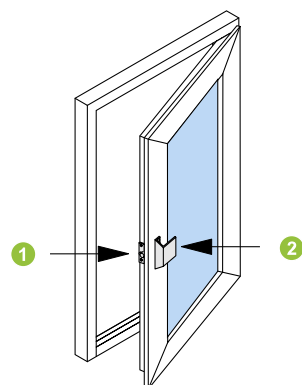

① The roller catch holds the vent in the closed position without locking using a handle or other fittings. Units with spring catches can be fitted with a door pull on the outside. ②

**Operation:**

The vent is opened and closed with a light push or pull.

### 2.35 Limiting stay

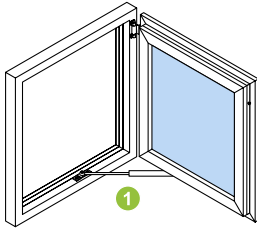

The limiting stay restricts the opening angle of the side-hung vent to 90°. It prevents movement of the vent in a draught. The limiting stay is maintenance free and must not be oiled. ①

### 2.36 Anti-slam fitting

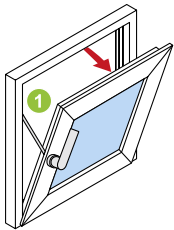

① The anti-slam fitting prevents the vent from slamming shut in the tilt position. It prevents damage caused by draughts pulling the vent open or slamming it shut. The anti-slam fitting requires no maintenance.

## 3.0 Operation: Doors (Danger of crushing for door locks.)



### WARNING

Opening the doors and using the key at the same time can lead to fingers being trapped between the frame and the door leaf. Do not use the key to move the door leaf.



### INFORMATION

All locks are activated by one turn of the key. However, the burglar-resistant function of the doors is only ensured by a full turn of the key.

Single throw locks: one turn

Double throw locks: two turns

### 3.1 Door locks, external door with door pull

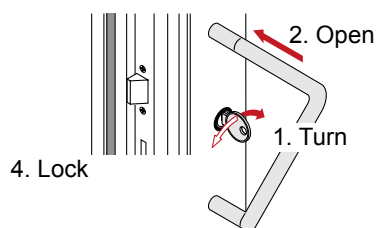

#### To open lock from inside/outside:

1. Turn the key against the spring towards the infill side and hold for a short time.
2. Open the door slightly and release the key immediately.
3. Open the door wide.
4. Close the door.
5. Lock the door by full turns of the key towards the frame side.

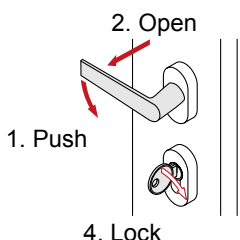

#### To open/lock from inside:

1. Press door handle down.
2. Open the door.
3. Close the door.
4. Lock the door by full turns of the key towards the frame side.

### 3.2 Door locks, external door with door handle

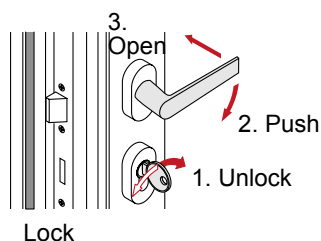

#### To open from inside/outside:

1. Unlock the door by full turns of the key towards the infill side.
2. Press door handle down.
3. Open the door.

**Close in the reverse order.**

### 3.3 Door locks, door with intruder catch

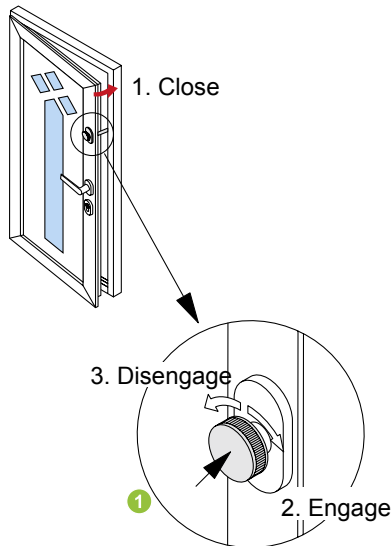

The intruder catch limits the opening angle of the door leaf to a small gap. The intruder catch must be re-engaged manually.

**To engage the intruder catch:**

1. Close the door leaf.
  2. Engage the intruder catch by rotating the thumb turn clockwise. ①
- The door leaf can only be opened as far as the catch allows.

**To disengage the intruder catch from the inside:**

3. Engage the intruder catch by rotating the thumb turn anti-clockwise. ①
4. The door leaf can now be opened wide.

**To disengage the intruder catch from the outside:**

- ▶ The intruder catch can be disengaged from the outside by following a specific locking sequence.



**INFORMATION**

See points 3.1/3.2 for operation of the door handle and lock.

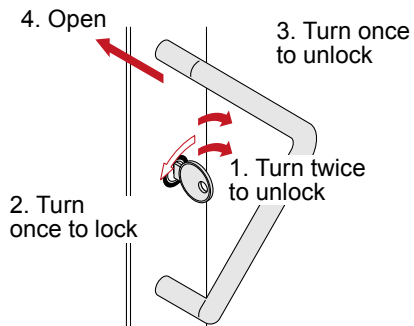

**Locking sequence:**

1. Unlock the door by two full turns of the key towards the infill side.
2. Unlock the door by one full turn of the key towards the frame side.
3. Unlock the door by one full turn of the key towards the infill side.
4. Turn the key against the spring towards the infill side and open the door.

### 3.4 Door locks, door with automatic locking (self-locking)

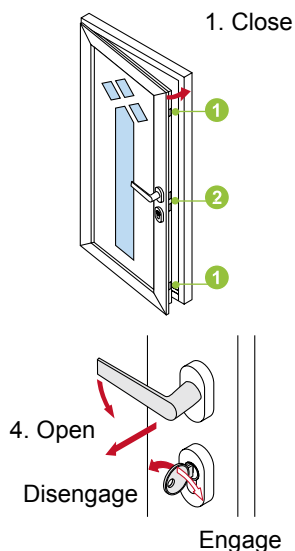

This type of lock has additional latches at the top and bottom of the door leaf. ①

#### Open/close door

1. The top and bottom latches lock the door automatically against it being opened from outside. ①
2. The door can be opened from the inside using the handle.

#### Fully unlock the door.

- ▶ Locking the door with the key prevents it from being unlocked from the inside as well. The door handle is now blocked! ②

#### Fully unlock the door.

- ▶ The fully locked door can be opened from inside using the key (turning) and the handle.

### Door locks, door with electric opener

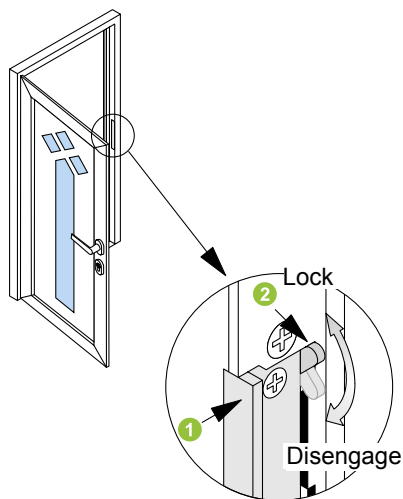

A separately mounted switch releases the closed door for opening.

Once released, the door can only be opened for as long as the switch is operated.



#### INFORMATION

The electric opener will not release the door if it has been locked using the key.

#### Daytime setting:

- ▶ During the day, the latch on the electric opener can be permanently disengaged.
- The door can be opened at any time if the latch is disengaged. ①

#### Engaging and disengaging:

- ▶ Engage or disengage the latch by moving the catch. ②

### 3.6 Door locks, door with electric locking

Doors with electrically operated locking are opened and closed by a motor integrated into the door, and are operated by the door handle or by remote control. For more information, see the separate operating instructions.

### 3.7 Door lock, door with lock with electric coupling

These locks can be used with an outside handle with electric coupling on single and double-leaf doors with access control systems. For locks with electric coupling, the outside handle is engaged, i.e. the door handle allows access. The door handle can therefore be engaged and disengaged.



#### INFORMATION

The lock with electric coupling can be controlled centrally so that, when closed, the doors are immediately no longer accessible. The door can be controlled by door opener switches, intercom systems, timers or access control systems.

### 3.8 Door locks, door with locking cylinder with locking thumb turn

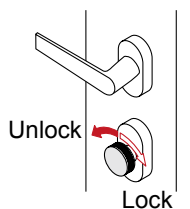

This locking cylinder is operated from the outside using a key and from the inside using the locking thumb turn.

#### To lock:

1. Close the door.
2. Lock the door by full turns of the locking button towards the frame side.

**To unlock, follow the same procedure in reverse order.**

### 3.9 Door locks, double-leaf doors

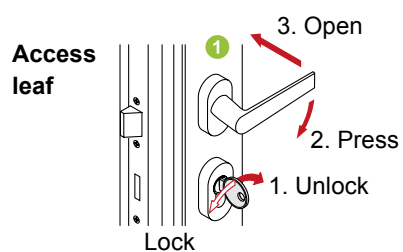
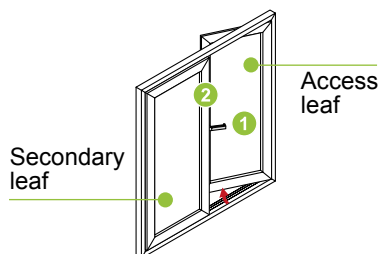

#### Open access leaf.

1. Unlock the door by full turns of the key towards the infill side.
2. Press down door handle. ①
3. Open door.

#### Close in the reverse order

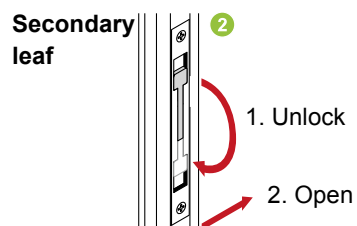

#### Open the secondary leaf:

1. Open access leaf.
2. Release rebate lever. ②
3. Open secondary leaf.

#### Close in the reverse order

### 3.10 Door locks, double-leaf door with panic function

#### a.) Door handle (DIN EN 179)

When the door is locked, one or both leaves can be opened in an emergency using the door handle.

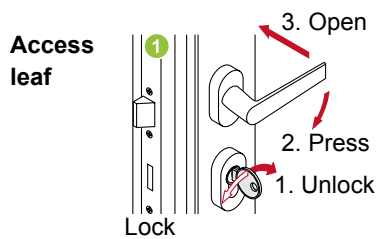
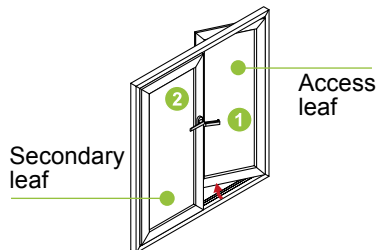

#### Open the access leaf (panic function):

1. Unlock the door by full turns of the key towards the infill side.
2. Press down door handle. ①
3. Open access leaf.

#### Close

1. Close the door.
2. Lock access leaf by one full turn (panic function) of the key towards the infill side.

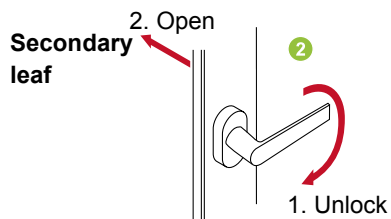

#### To open the secondary leaf:

1. Press down door handle. ①
2. Open access leaf and secondary leaf.

#### Close

1. Close the secondary leaf first.
2. Then close the access leaf.

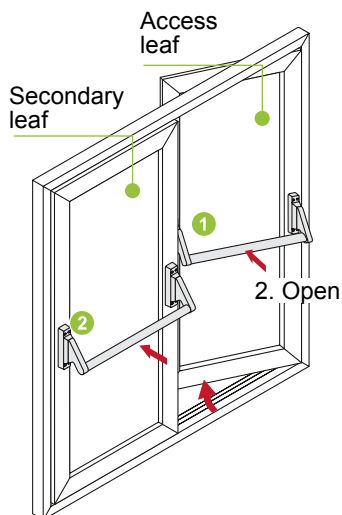
**b.) Push bar (DIN EN 1125)**

Locked doors can be opened in an emergency using the emergency push bars.

**INFORMATION**

Always first lock the secondary leaf, then lock the access leaf.

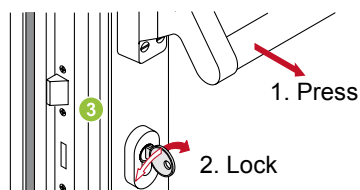
**Access leaf****Open the access leaf (panic function):**

1. Push emergency push bar. ①
2. Push access leaf open.

**To lock the access leaf:**

- ▶ to the secondary leaf side. ③

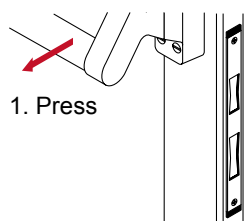
**Secondary leaf****To open the secondary leaf:**

1. Push emergency push bar. ②
2. Push secondary leaf open (access leaf is also pushed open).

**To lock the secondary leaf:**

1. Close the secondary leaf.
2. Locking is automatic using a special switch latch.

**To unlock secondary and access leaves:**

1. Both door leaves are opened by operating the emergency push bar on the secondary leaf. ②
2. The access leaf is unlocked by operating its emergency push bar.

### 3.11 Magnetic door stop

If the magnetic free-moving lever comes into contact with the metal floor plate, it is engaged and brought to a gentle stop at the end of the slot. The door stop is maintenance-free and can be retrofitted.



#### INFORMATION

The magnetic door stop has been approved for emergency exits and escape routes.



#### NOTE

The magnetic door stop does not have a retaining catch.

### 3.12 Door stop

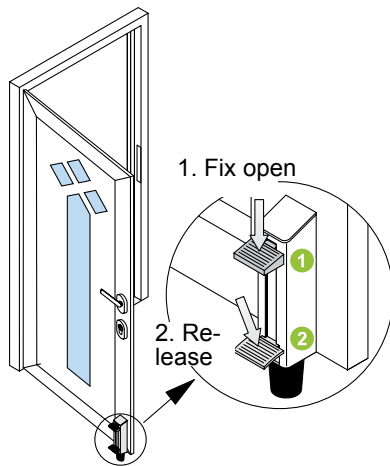

The door leaf can be fixed open using the door stop.

#### Fix open:

- ▶ Secure door stop by operating the pedal. ①

#### Release:

- ▶ Release door stop by operating the release pedal. ②

### 3.13 Door closer

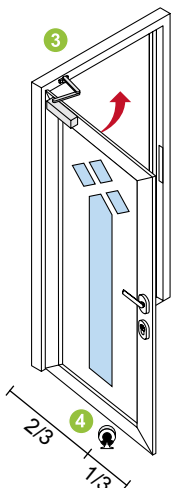

The door closer automatically returns the door leaf to the closed position. Some door closer hold the door leaf in the wide open position. To close the door, it must be pulled once in the closing direction, and thereafter it will close automatically. ③

For door closers, as a rule, a door stop must be used. ④

## 4.0 Misuse



### NOTE

Note the following advice to prevent damage to window and door units.

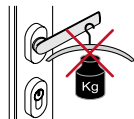
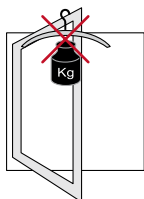

#### Do not load extra weight onto the frame or handles.

The additional load can cause deformation of the unit frame or damage to the handles.



#### Operate the handles in the correct direction only and do not force them beyond the anti-turn stop.

The additional load can lead to damage to the handles.

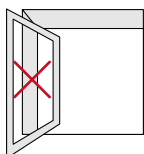

#### Do not rest the vents against projecting walls.

Damage to the vents can be caused by draughts slamming the vents open and shut.

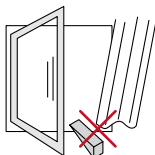

#### Do not wedge anything between the vent and the frame.

The additional load can cause deformation of the frame.

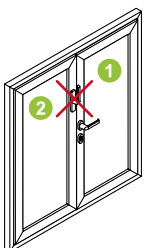

#### Double-leaf doors must NOT be opened using the secondary leaf (exception: emergency doors).

The additional load can cause deformation of the frame or damage to the locks.

- ① Access leaf with door handle
- ② Secondary leaf

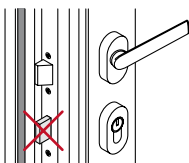

#### Do NOT turn the locks when the doors are open.

Closing the door when the lock is engaged can damage the door frame.

## 5.0 Cleaning and maintenance

### 5.1 General information

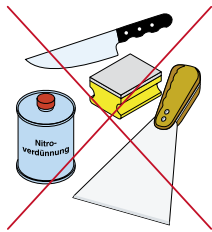

The following items must NOT be used for cleaning:  
Tools with sharp edges, e.g. knives, metal scrapers, steel wool, the scouring side of household sponges etc. will damage surfaces. Aggressive cleaning fluids or solvents, e.g. cellulose thinner, nail polish remover etc. will also cause irreversible damage to unit surfaces.

### 5.2 Cleaning and maintenance materials



Cleaning fluids suitable for aluminium units are available from Schüco specialists.

Aluminium maintenance kit 298 672:

1. Cleaner and preservative.
2. Lubricating spray to maintain fittings.
3. Grease stick to maintain gaskets.
4. Touch-up sticks.

Maintenance materials for anodised aluminium units:

1. Basic cleaner 298 181  
For initial and basic cleaning. Cleans and preserves the aluminium surface
2. Metal polish 298 010  
This cleaner for anodised surfaces restores the matt finish to the aluminium and preserves the surface (can also be used on stainless steel).
3. Universal aluminium cleaner 298 001  
Removes stubborn grime, minor scuff marks and scratches.



#### NOTE

For cleaning colour-coated units, observe the instructions on the cleaning agent.

### 5.3 General cleaning advice

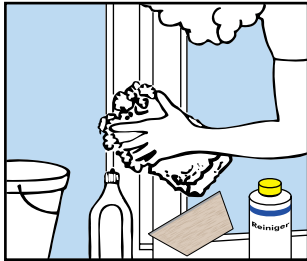

For the best window care, clean the window frames and gaskets at the same time as the window panes. Use a mild, non-scouring cleaning agent.

#### **Solid substances**

Plaster, mortar or similar is best removed using a wooden or plastic spatula.

#### **Marks**

Can be removed safely and without residue using a cleaning agent from our range of cleaning products for aluminium units.



#### **CAUTION!**

To prevent damage, observe the instructions for use given on the cleaning agent.

## 6.0 Maintenance

In addition to normal cleaning and maintenance, you should carry out a brief inspection of your aluminium units annually. This will extend the working life of the units and maintain ease-of-use.

Have power-operated windows (e.g. with Schüco TipTronic mechatronic fittings) safety checked at least once a year by a specialist company. Existing safety catches must also be checked. The test must be documented.



### NOTE

The fittings, window, door and facade units require specialist, systematic maintenance/care and inspection to ensure they maintain their value and remain fit for use and safe. Therefore, it is recommended to conclude a corresponding maintenance contract with a specialist window, door and façade company.



### WARNING

When releasing the chain actuators of Schüco TipTronic projected top-hung units, the vent might move unexpectedly. There is a risk of crushing and a danger of objects falling out. Secure the vent before releasing the actuators. Ensure that the entire weight of the vent is supported.

A safety barrier is stipulated for “power-operated bottom-hung windows” with only one chain actuator (see VFF data sheet KB0.1). Secure the vent before releasing a fixing unit. Ensure that the entire weight of the vent is supported.



### WARNING

Risk of injury due to maintenance work carried out incorrectly. Incorrect maintenance could lead to severe injury or damage to property.



### INFORMATION

In addition, observation of the following guidelines is recommended:

- WP.01 of the German Association of Window and Façade Manufacturers (VFF)
- Maintenance of windows, façades and external doors – maintenance, care and inspection – notes for sales
- WP.02 of the German Association of Window and Façade Manufacturers (VFF)
- Maintenance of windows, façades and external doors – maintenance, care and inspection – action and documents
- WP.03 of the German Association of Window and Façade Manufacturers (VFF)
- Maintenance of windows, façades and external doors – maintenance, care and inspection – maintenance contract

### 6.1 Cleaning the drainage slot

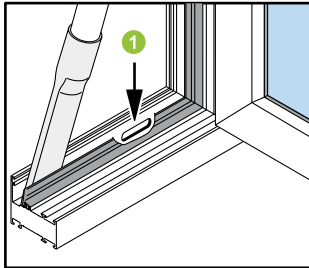

- ▶ Remove dust and dirt from the space between the gaskets and the external side of the frame using a vacuum cleaner.
- ▶ Blocked drainage slots can be cleaned using, for example, a cocktail stick or cotton bud. 1

### 6.2 Cleaning the roller guides of sliding and folding units

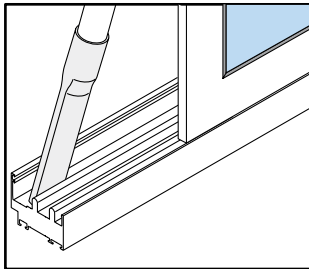

- ▶ Remove dust and dirt from the roller guides on the bottom side of the frame using a vacuum cleaner.

### 6.3 Checking and lubricating the gaskets

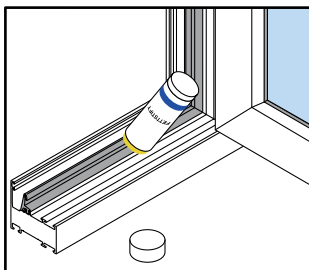

- ▶ Rub all gaskets with a grease stick or Vaseline. This will maintain suppleness and prevent sticking. At the same time, check all gaskets for damage.



Ask a Schüco specialist to replace any defective gaskets.

## 6.4 Maintenance of fittings components

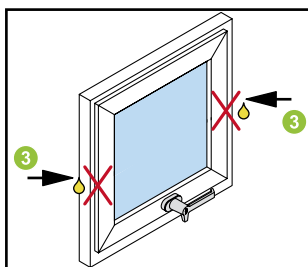
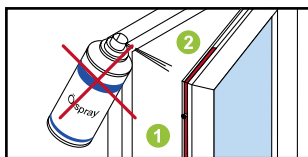
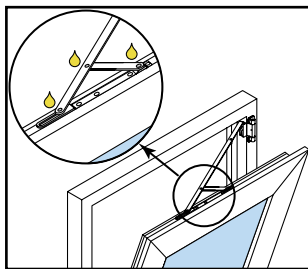
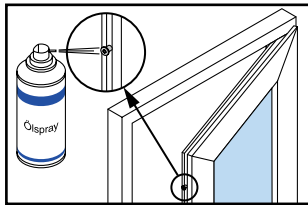

All moving parts of the fittings in your Schüco units are virtually maintenance free. However, a little acid-free oil and grease keep the mechanics smooth and ensure user comfort for a long period.

Spray the locking pins and the positioning points of the tilt stay with the lubricant spray from the Schüco range.



### NOTE

Only a light application is required at all points.

To avoid contamination, wipe off excess lubricant after lubrication.

1. ① The locking bars, the locking bar guides and the corner drives are lubricated during fabrication and do not require maintenance. ②
2. The pivots of the vertical pivot windows are fitted with brakes to hold the unit open. ③
3. Do NOT oil or lubricate the pivots, otherwise the vent could swing open and shut in an uncontrolled way.

### Maintenance work to be performed at least once a year (in school and hotel buildings every six months)

- ▶ Ensure fittings components are secure and check for any signs of wear. If required, tighten fixing screws and have a specialist company replace worn components.
- ▶ Grease all moving parts and locking parts of the fittings and check for proper functioning.

## 6.5 Doors

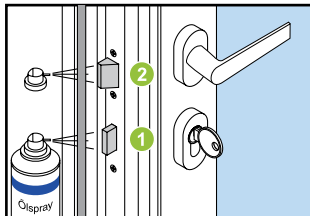

For doors, the latch (1) and bolt (2) on the door lock must be lubricated as necessary.

**Before lubrication:**

► Lock the door to expose the bolt.

**After lubrication:**

► Unlock the door to conceal the bolt.

For doors with a touch bar / push bar, the gearboxes on the left and right-hand side must be lubricated twice a year. At the same time the tightness of the screws has to be checked and if required tightened to 2-2.5 Nm. ①

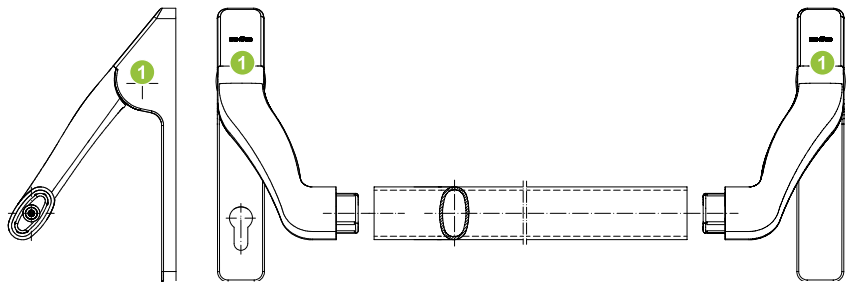

## 6.6 Maintaining the locking cylinder

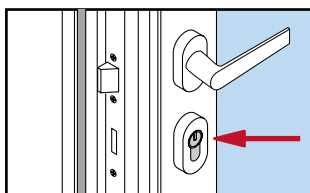

Depending on the loading, the locking cylinders have to be maintained at least twice a year.

► Only use graphite powder to lubricate the locking cylinder.

## 6.7 Door hinges

### Surface-mounted door hinges



Surface-mounted hinge, 3-part

### Barrel hinges



Barrel hinge, 3-part (aluminium)

### Concealed door hinges

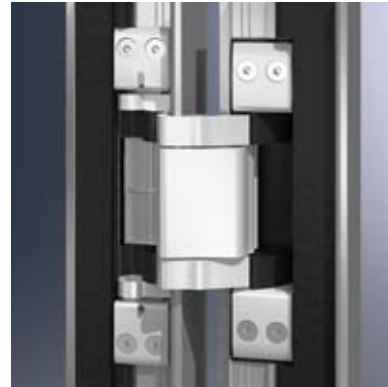

180° concealed hinge

#### Check door hinges:

- Check the door hinges are secure and check for damage. If required, tighten the fixing screws or have the parts replaced by a Schüco specialist.

#### Adjust the door hinges:

- If required, adjust the door hinges horizontally or vertically using the corresponding adjustment screws to ensure a uniform shadow joint and perfect door functioning.

#### Maintain the door hinges:

- The door hinges are maintenance-free and are not permitted to be lubricated or greased.



#### NOTE

For concealed 100° hinges, a door stop generally has to be used.

## 7.0 Correct ventilation

### How to prevent damage caused by dampness

The high weathertightness of the Schüco window systems reduces the exchange of air between the inside and outside. Depending on use, high humidity loads could occur. This is caused by evaporation from people and plants and facilities with high humidity levels such as bathrooms and kitchens.

The accumulation of water vapour leads to an increase in humidity and has to be let out to prevent damage caused by damp. The formation of condensation on materials that are not sensitive to water such as aluminium window frames and glass is permissible for a short time and in small quantities (DIN 4108-2). This phenomenon can be countered by sufficient ventilation.



#### INFORMATION

You can find additional information on the subject of ventilation in the separate manuals for the Schüco VentoTherm ventilation system and Schüco VarioAir window ventilator.

### 7.1 Ventilating in summer/winter

#### Summer

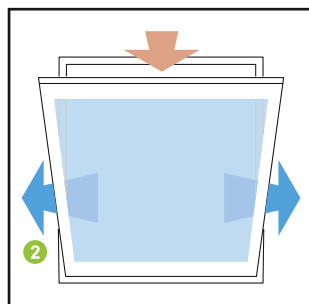
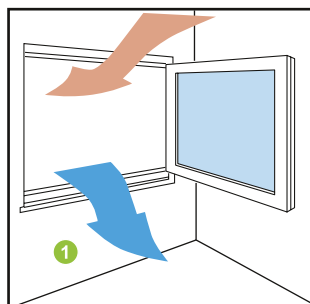

- ① Short blast ventilation
- ② Prolonged ventilation only when heating is switched off.

#### Winter

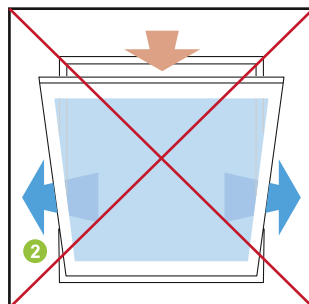
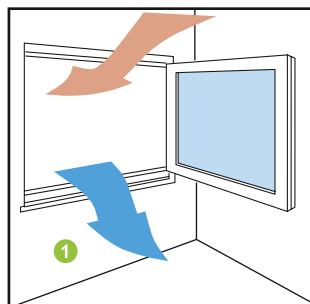

- ① Short blast ventilation
- ② Avoid permanent ventilation through tilted windows in winter to prevent the interior becoming too cold.





## 7.2 Blast ventilation

Depending on use, the window should be completely opened several times a day to ensure blast ventilation. As illustrated the perfect ventilation time depends on the time of year and should be in the range of 4-6 minutes in winter.

Blast ventilation ensures maximum protection against moisture damage. This effective exchange of damp air requires little heat energy as the interior barely cools down at all during the short period of ventilation.

The ventilation is even more economical if during ventilation the thermostat valve is turned off during ventilation and back on again after the windows are shut again.

### Recommended duration of blast ventilation in the months:

December, January, February	4 - 6 minutes	
March, November	8 - 10 minutes	
April, October	12 - 15 minutes	
May, September	16 - 20 minutes	
June, July, August	25 - 30 minutes	

Ventilation time required to exchange the air during blast ventilation (wide open window with no wind) depending on seasonal outside temperature.

## 8.0 Advice and repairs

If these operating instructions do not answer all your questions, refer to your Schüco specialist for help.

In addition to providing expert advice, a specialist dealer can advise you on particular modifications and repairs.

### 8.1 Maintenance agreement

Schüco specialists can offer you the additional service of a maintenance agreement.

Under the terms of the maintenance agreement, the Schüco specialist will undertake all maintenance and repair work. Your aluminium units will be maintained at their optimum functional performance and value without the need for additional resources.



#### **NOTE**

All repairs and modifications should be undertaken by a Schüco specialist. Only repairs by a specialist using original parts guarantee the continued correct operation of your Schüco units.